

Pressure-Matic

Automatic Pressure Reducing and Checking Device Valves

Sprinkler systems are required to have a check valve in front of the floor control valve in dual riser systems. This added cost and installation is eliminated with Elkhart's patented Pressure-Matic automatic pressure reducing valves. Pressure-Matic valves are listed as a checking device by Underwriter's Laboratories, Inc., and offered a 1 1/2" and 2 1/2" valves. They operate automatically by inner hydraulic controls and serve as a floor control valve, as a standpipe valve and as a checking device. Constructed of brass, they will fit all existing hose cabinets where 1 1/2" and 2 1/2" valves are used. They are available in rough brass with optional finish of polished brass body and rough chrome plated or polished chrome plated body.

Engineering Specifications

Elkhart UR-20-1.5 (W, X, Y, YZ, Z, ZA, ZB, ZZ, ZZA)

UR-20-2.5 (A, B, C, CD, D, DE, E, EF, F)

UR-20S-2.5 (A, B, C, CD, D, DE, E, EF, F)

UR-25-1.5 (W, X, Y, YZ, Z, ZA, ZB, ZZ, ZZA)

UR-25-2.5 (A, B, C, CD, D, DE, E, EF, F)

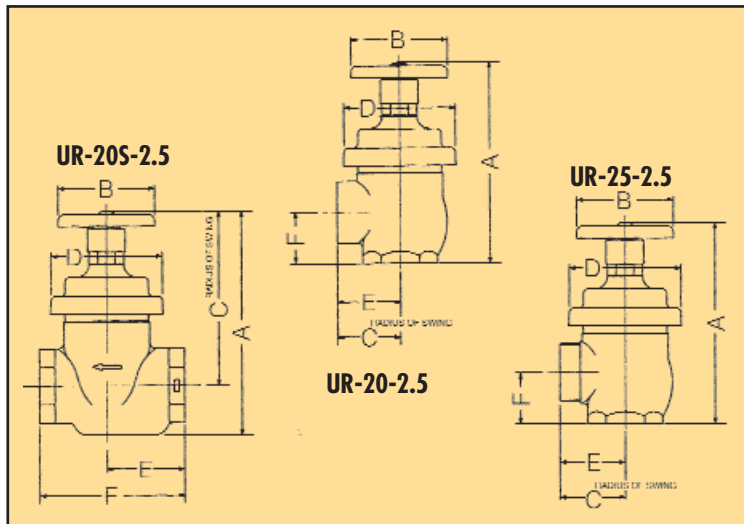

Pressure-Matic automatic pressure reducing valves for use on high pressure standpipes to control nozzle pressure or pressure to an automatic sprinkler branch or zone, under both flow and no-flow conditions as required by NFPA Standards #13 and #14. Each valve to be listed by Underwriters' Laboratories, Inc.

Threads

UR-20-1.5 (W, X, Y, YZ, Z, ZA, ZB, ZZ, ZZA) Female inlet and outlet 1 1/2" N.P.T. (also available with 2" N.P.T. female outlet).

UR-20-2.5 (A, B, C, CD, D, DE, E, EF, F) Female inlet and outlet 2 1/2" N.P.T.

UR-20S-2.5 (A, B, C, CD, D, DE, E, EF, F) Female inlet and outlet 2 1/2" N.P.T.

UR-25-1.5 (W, X, Y, YZ, Z, ZA, ZB, ZZ, ZZA) Female inlet 1 1/2" N.P.T., Male outlet any 1 1/2" Fire Department thread.

UR-25-2.5 (A, B, C, CD, D, DE, E, EF, F) Female inlet 2 1/2" N.P.T. Male outlet any 2 1/2" Fire Department thread. (Also available with 3" male outlet.)

Each valve to be tagged by manufacturer for each hose station or valve location. Specify optional cap and chain when required with UR-25-1.5 or UR-25-2.5 (Specify optional 3" cap and chain for 3" outlet.) Specify optional automatic signal function bracket. Finish: Rough brass.

Optional finish: Polished brass body and rough chrome plated or polished chrome plated body.

Monitor Switch Brackets

Potter Electric Signal Co., Switch #OSYS-B

Potter Electric Signal Co., Switch #PIVS-U

Potter Electric Signal Co., Switch #PIVS-U-A1

Potter Electric Signal Co., Switch #PIVS-U-A2

Potter Electric Signal Co., Switch #PIVS-B

N-CO Switch Model #SGV, Notifier Co.

N-CO Switch Model #NGV, Notifier Co.

Grinnel Monitor Switch, Model #F640 (GEM)

Alarm Systems, Inc., Switch Model #600S1

CATALOG NUMBER	NOMINAL PIPE SIZE	APPROX. WT. LBS.	DIMENSIONS IN INCHES						
			A		B	C	D	E	F
			MIN.	MAX.					
UR-20-1.5 (W, X, Y, YZ, Z, ZA, ZB, ZZ, ZZA)	1 1/2	7 1/2	7 3/4	8 1/4	4	2 1/2	3 1/2	2 3/16	1 7/8
UR-25-1.5 (W, X, Y, YZ, Z, ZA, ZB, ZZ, ZZA)									
UR-20-2.5 (A, B, C, CD, D, DE, E, EF, F)	2 1/2	18 1/2	10 9/16	11 3/8	5	3 3/8	5 7/8	3 1/4	2 13/16
UR-25-2.5 (A, B, C, CD, D, DE, E, EF, F)									
UR-20S-2.5 (A, B, C, CD, D, DE, E, EF, F)	2 1/2	26 1/2	11 3/4	12 9/16	5	9 9/16 to 10	5 7/8	4	7 1/2

Eliminates Cost and Installation of Separate Check Valve

Underwriters' Laboratories Listed, Patent Nos. 4,249,717 – 4,008,735 – 3,994,255. Canadian Patent No. 1,007,952.

(A) Supervised Capability Function—When equipped with bracket and switch, the Pressure-Matic valve can be used in a supervised system to produce an audible and/or visual alarm in case the valve is closed.

(B) Automatic Check Valve Function—UL listed as having automatic checking feature. When dual risers are used and sprinklers are fed from both, Pressure-Matic operates as a check valve to prevent loss of sprinkler pressure in the event of damage to one riser.

IMPORTANT: When hydrostatically testing the sprinkler system, Pressure-Matic can be subjected to pressure up to its full rating (400 P.S.I.) without damage to the valve.

(C) Floor Control Valve—Pressure-Matic is listed by Underwriters' Laboratories as a floor control valve in automatic sprinkler systems and as such is equipped with an open-close visual indicator. The 1½" valves can be used for flows up to 250 GPM and the 2½" valves for flows up to 500 GPM. Pressure-Matic is now available in the straight (globe) pattern (2½" size only) for more versatile and economical installation, for flows up to 400 GPM.

(D) Standpipe Valves—Pressure-Matic is listed by Underwriters' Laboratories for use as a standpipe valve for pressure regulation under both flow and no-flow conditions. This is as specified by NFPA Standard #14 for Class I, Class II and Class III systems.

Pressure-Matic is a true pressure reducing valve in both the 2½" and 1½" sizes. Operating automatically by internal hydraulic controls, it can substantially reduce the initial costs for standpipe and sprinkler system fire protection installations. Pressure-Matic fits all existing cabinets where valves are installed.

The accurate control of pressure by Pressure-Matic can also cut costs by reducing the amount of heavy-duty pipe and fittings, as well as the number of valves previously necessary on sprinkler systems. Under some circumstances, it can replace as many as three valves.

Pressure-Matic action is completely dependent on conditions at the nozzle or sprinklers. The inner hydraulic system controls pressure under all flow and no-flow situations. There are no diaphragms, springs or outside controls involved. Its top rating of 400 P.S.I. exceeds the highest allowable pressure under NFPA Standard #14. It is also listed by UL of Canada for 400 P.S.I. service.

Pressure-Matic is listed by Underwriters' Laboratories under two separate categories: standpipe valves for Class I, Class II or Class III service, and sprinkler floor control valves suitable for indicating service.

Standpipe Systems

Class I—for use by trained fire personnel. The 2½" Pressure-Matic provides Class I service as outlined by NFPA Standard #14. The valve fits standard size fire cabinets.

Pressure-Matic acts as a shut-off valve, as well as a pressure reducing valve, under both flow and no-flow conditions. It provides for simplified testing, too. When Pressure-Matic valves are used in a standpipe system, the system can be hydrostatically tested at 200 P.S.I. or more as called for by NFPA Standard #14, paragraph 8-1.1. It is not necessary to disassemble or blank off the valve or to take other steps to protect internal parts.

Automatic Signal Function Bracket and a Visual Indicator are available as options.

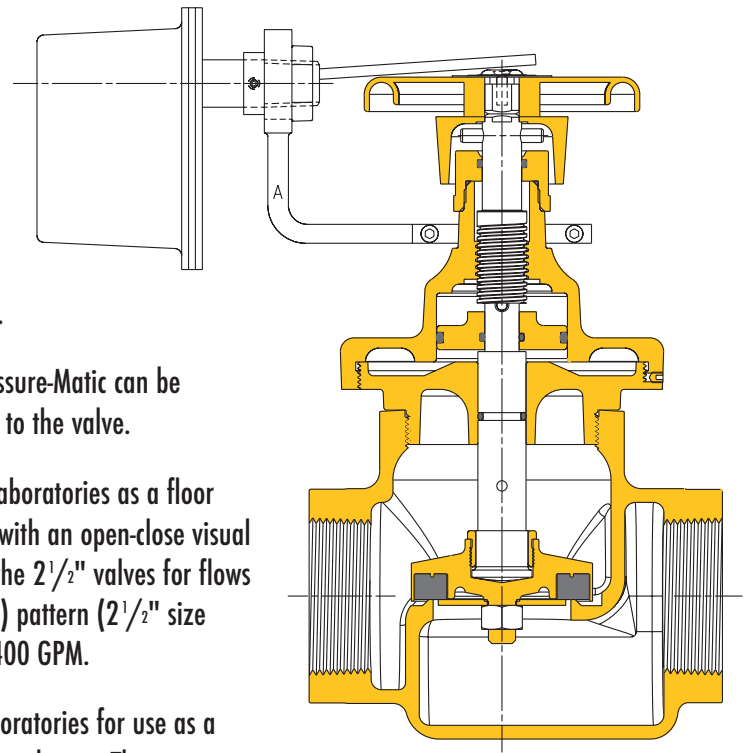

Class II—for use by building occupants. The 1½" Pressure-Matic meets the requirements for Class II service as outlined by NFPA Standard #14. The valves control the pressure to 1½" hose rack units under both flow and no-flow conditions, thus allowing the use of rubber lined hose, shut-off nozzles and periodic testing.

Class III—for use by building occupants and trained fire personnel. The 2½" Pressure-Matic valve provides Class III service as outlined in NFPA Standard #14. The valve controls nozzle pressure for the use of 1½" hose and nozzle by building occupants. The 2½" x 1½" hose reducer can be removed, together with the 1½" hose, and Pressure-Matic will continue to control the nozzle pressure without any valve adjustment under flow and no-flow conditions of the Fire Department hose line.

Automatic Sprinkler Systems

Pressure-Matic provides a floor control valve in an automatic sprinkler system and both 1½" and 2½" sizes are listed by Underwriters' Laboratories for such use. It is equipped with an open/close visual indicator. The 1½" valve can be used for flows up to 200 GPM and 2½" size up to 500 GPM. The sprinkler system can be pressure tested as required in NFPA Standard #13, paragraph 1-11.2 with back pressure up to the full 400 P.S.I. rating (300 P.S.I. for 1½") of Pressure-Matic without damaging the valve. Pressure-Matic also operates as a check valve at pressure up to 400 P.S.I. in dual riser systems where sprinklers are fed from both to prevent loss of sprinkler pressure in case of damage to one riser. Since it serves as a check valve, a floor control valve and a pressure reducing valve, it can replace three valves in many cases. The new straight pattern body allows greater versatility and economy in locating the floor control valve installation. In cases where flows to sprinkler branch lines are not required to be over 200 GPM, the less expensive 1½" Pressure-Matic Angle Valve fills the requirement and may be used.

An optional bracket allows the use of supervisory switches. U.L.I. listed up to 400 P.S.I.

All valves are factory tested at 600 P.S.I.

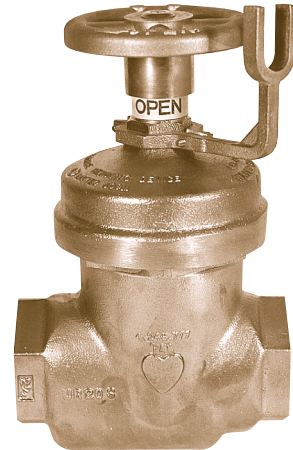

UR-20S-2.5

Choosing the Correct Elkhart Pressure-Matic Valve

1. Determine standpipe or sprinkler riser residual pressure for each valve location.
2. Turn to appropriate valve chart, based on valve size and body style. The valve flow range for each chart is indicated in the lower right corner of the chart. Be sure to use the correct chart for the designed flow rate through the valve.
3. Locate the valve inlet residual pressure on the vertical axis of the chart and draw a line from this pressure horizontally across the chart.
4. Locate the desired valve outlet residual pressure on the chart horizontal axis and draw a vertical line from this pressure value across the chart.
5. From the intersection of the inlet and outlet pressure lines constructed in 3 and 4 above, move horizontally to the nearest valve performance curve. This will be the appropriate valve for the chosen location.

EXAMPLE: Assume that the residual inlet pressure at a globe type sprinkler system floor control valve (PRV) is 275 psi at a design flow demand of 280 gpm. Assume a desired valve residual outlet pressure of 120 psi. On the appropriate chart it is seen that the intersection of the residual inlet and outlet pressure lines fall very close to the performance curve for the "DE" valve. Therefore, the "DE" valve would be chosen, and would provide an actual residual outlet pressure of 125 psi.

NOTE: In some instances, particularly in standpipe system designs, the desired valve outlet residual pressure is the maximum allowed by code. In such cases, it will be necessary to choose the valve closest to the left of the intersection of the inlet and outlet pressure lines. This procedure will prevent the outlet pressure from exceeding the maximum allowed by code.

6. To determine the valve static outlet pressure, refer to the appropriate static chart. Locate the standpipe or sprinkler riser static pressure on the vertical axis of the chart. Follow across to the appropriate valve curve and drop down to the horizontal axis to read valve outlet static pressure.

In the previous example assume the static inlet pressure is 290 psi. Follow the 290 psi inlet pressure line across the chart horizontally to the "DE" curve. Read the outlet static pressure of 153 psi on the horizontal axis directly below the point of intersection.

7. When sprinkler system supply pressure exceeds the maximum allowable static pressure on the system, it is recommended that a small relief valve be installed on the discharge side of each pressure reducing valve. Since the pressure reducing valve may be subjected to a large static pressure differential from inlet to outlet, the outlet pressure can easily build up to an undesirable level due to pump tests or slight leakage. Due to the incompressibility of water, a very minute amount of leakage, or even 'O'-ring deformation, can produce a large pressure increase on the downstream side of the valve.

Residual Pressure Charts for 2 1/2" Straight (Globe) Body Valve

2.5 PRESSURE-MATIC VALVE PERFORMANCE & SELECTION CHART – MODEL UR-20S

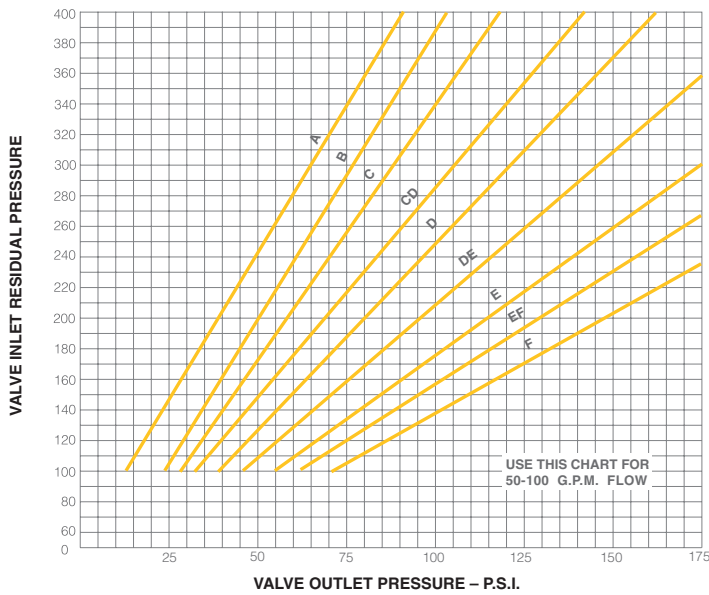

2.5 PRESSURE-MATIC VALVE PERFORMANCE & SELECTION CHART – MODEL UR-20S

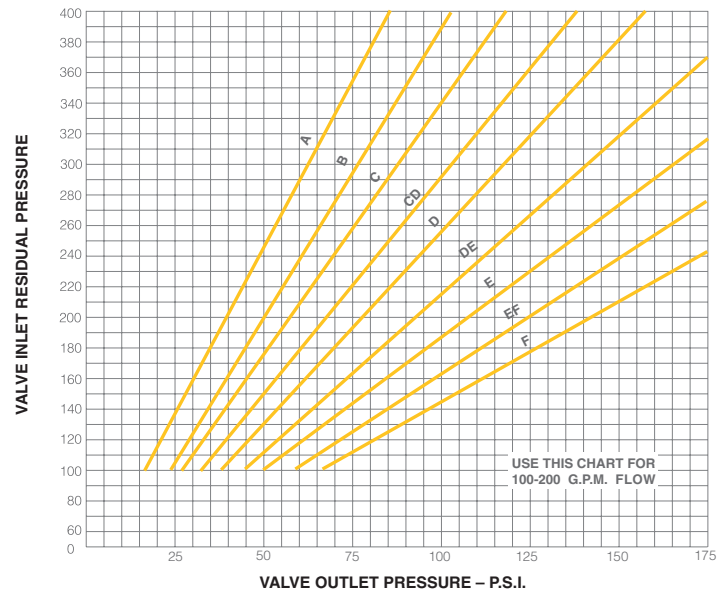

2.5 PRESSURE-MATIC VALVE PERFORMANCE & SELECTION CHART – MODEL UR-20S

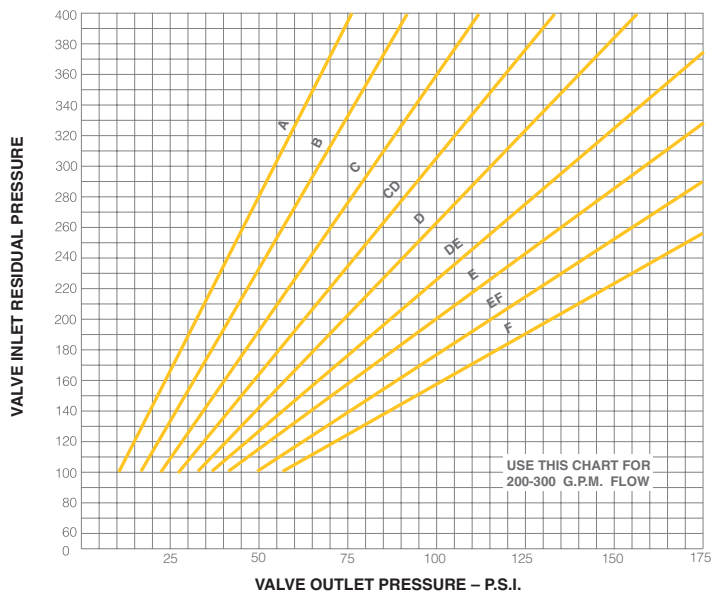

2.5 PRESSURE-MATIC VALVE PERFORMANCE & SELECTION CHART – MODEL UR-20S

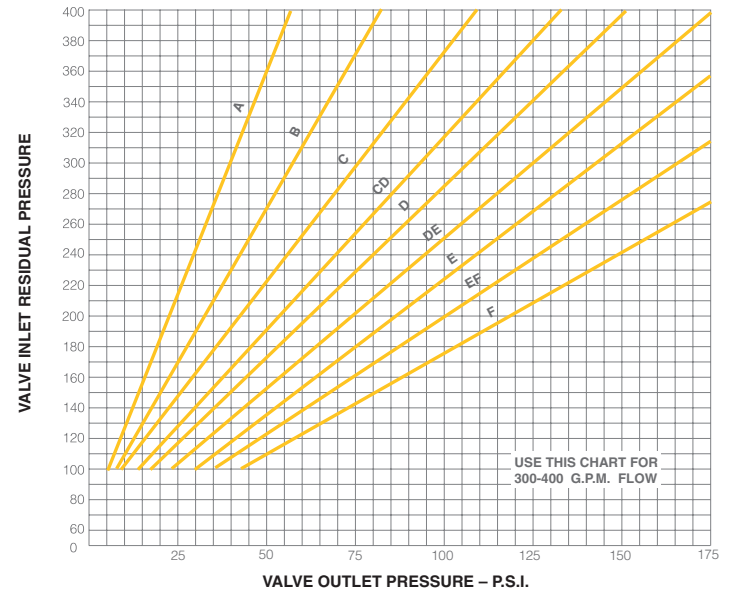

Residual Pressure Charts for 1 1/2" and 2 1/2" Angle Body Valves

2.5 PRESSURE-MATIC VALVE PERFORMANCE & SELECTION CHART – MODEL UR-20 & 25

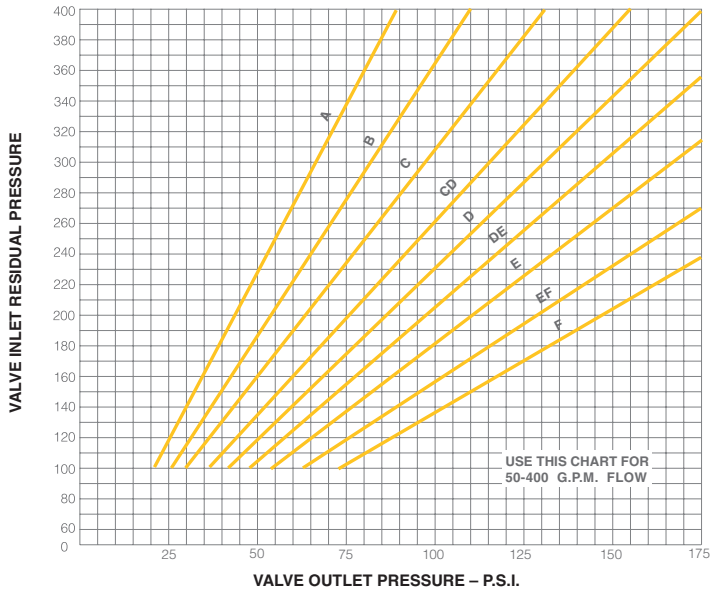

2.5 PRESSURE-MATIC VALVE PERFORMANCE & SELECTION CHART – MODEL UR-20 & 25

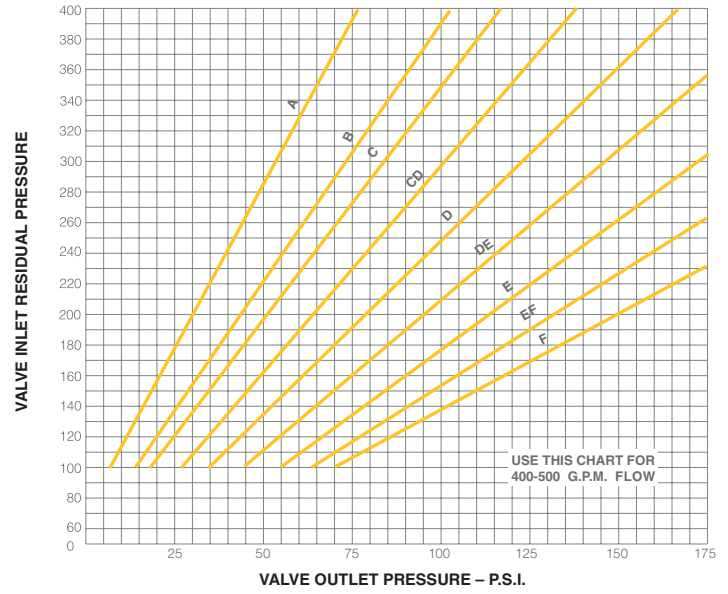

1.5 PRESSURE-MATIC VALVE PERFORMANCE & SELECTION CHART – MODEL UR-20 & 25

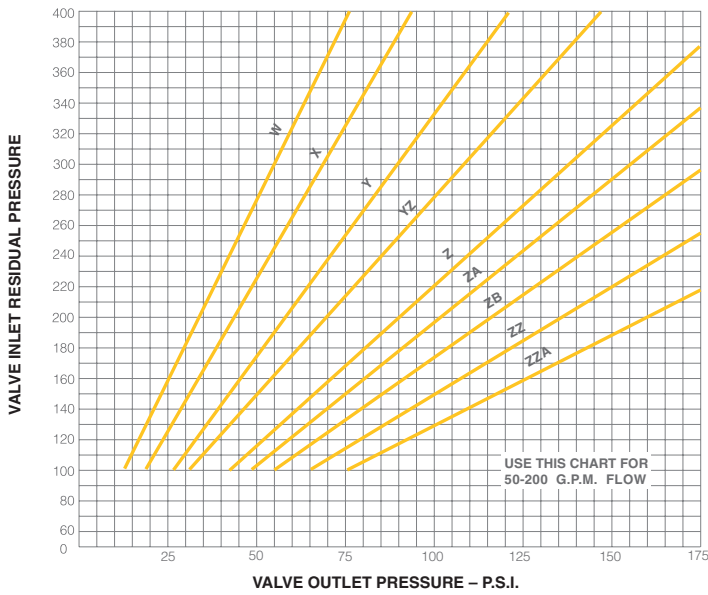

1.5 PRESSURE-MATIC VALVE PERFORMANCE & SELECTION CHART – MODEL UR-20 & 25

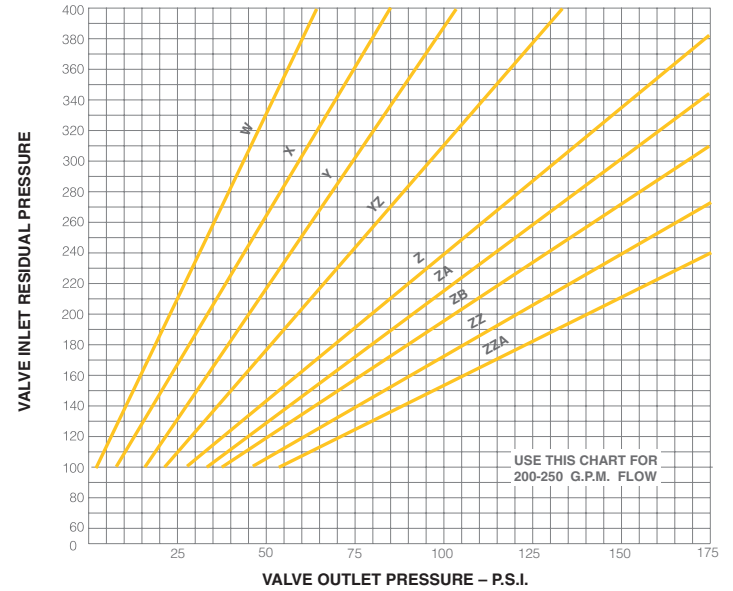

Static Pressure Charts for 2 1/2" Angle and Globe Body Valves and 1 1/2" Angle Body Valves

2.5 PRESSURE-MATIC VALVE PERFORMANCE & SELECTION CHART – MODEL UR-20, 25 & 20S

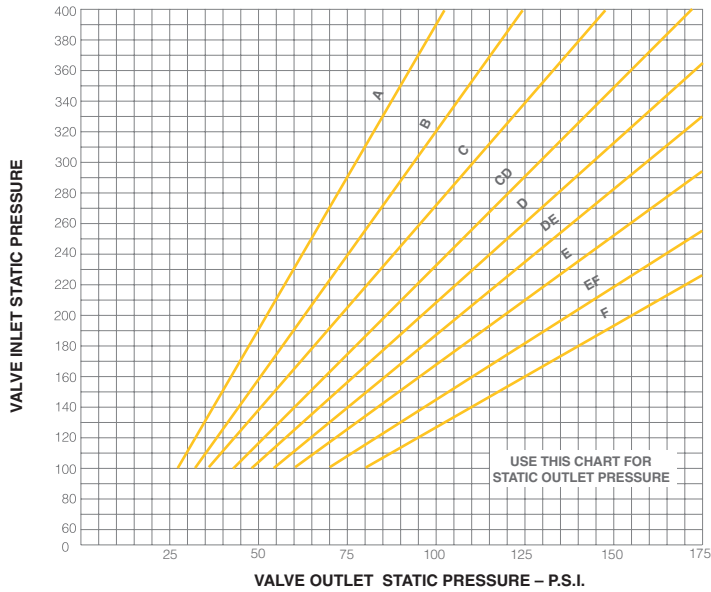

1.5 PRESSURE-MATIC VALVE PERFORMANCE & SELECTION CHART – MODEL UR-20, 25 & 20S

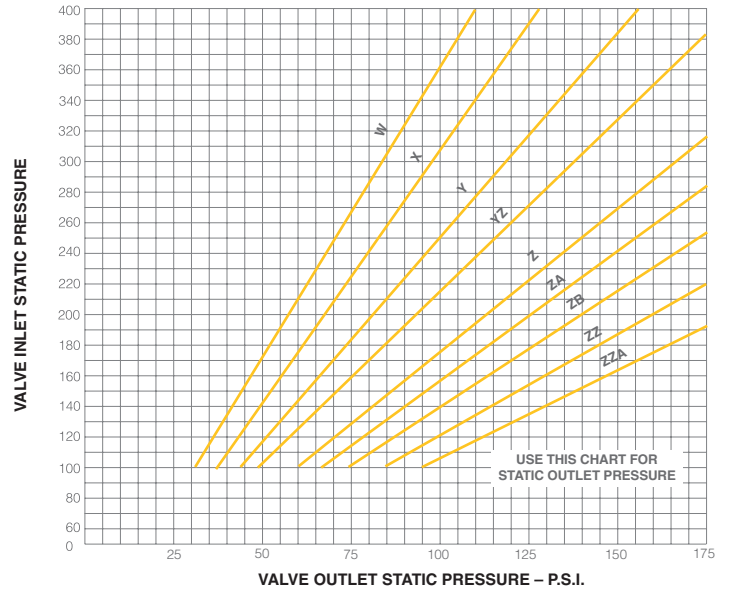

Consulting engineering services are available for new construction or revised fire protection systems. Our engineering staff has many years experience serving on N.F.P.A. committees and are continually in direct contact with Underwriters' Laboratories and Factory Mutual agencies. We also have direct contact with federal agencies and their specifications. Feel free to contact our office for product information, drawings, or technical assistance. Contact us for the nearest Elkhart distributor for aid in ordering Elkhart Brass Fire Protection Equipment.



UR-20-2.5

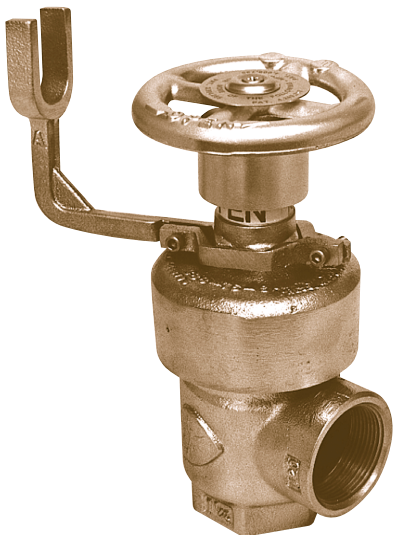

UR-20-1.5

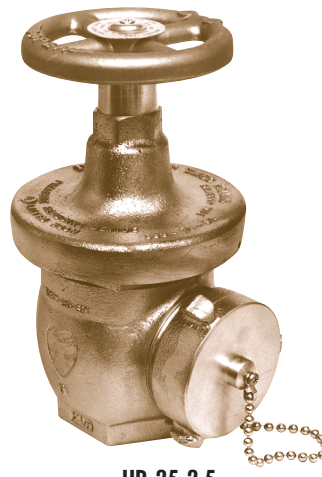

UR-25-2.5

